

# FH4602K

## N and P-Channel Enhancement Mode Power MOSFET

### Description

The FH4602K uses advanced trench technology to provide excellent  $R_{DS(ON)}$  and low gate charge .  
The complementary MOSFETs may be used to form a level shifted high sideswitch, and for a host of other applications.

### Applications

- Hhigh-frequency switching and synchronous rectification
- DC/DC Converter
- Surface mount package

### General Features

- **N-Channel** :  $V_{DS} = 20V, I_D = 4.0A$   
 $R_{DS(ON)}(Typ.) = 29 m\Omega @ V_{GS} = 4.5V$   
 $R_{DS(ON)}(Typ.) = 39 m\Omega @ V_{GS} = 2.5V$
- **P-Channel** :  $V_{DS} = -20V, I_D = -4.1A$   
 $R_{DS(ON)}(Typ.) = 32 m\Omega @ V_{GS} = -4.5V$   
 $R_{DS(ON)}(Typ.) = 39 m\Omega @ V_{GS} = -2.5V$

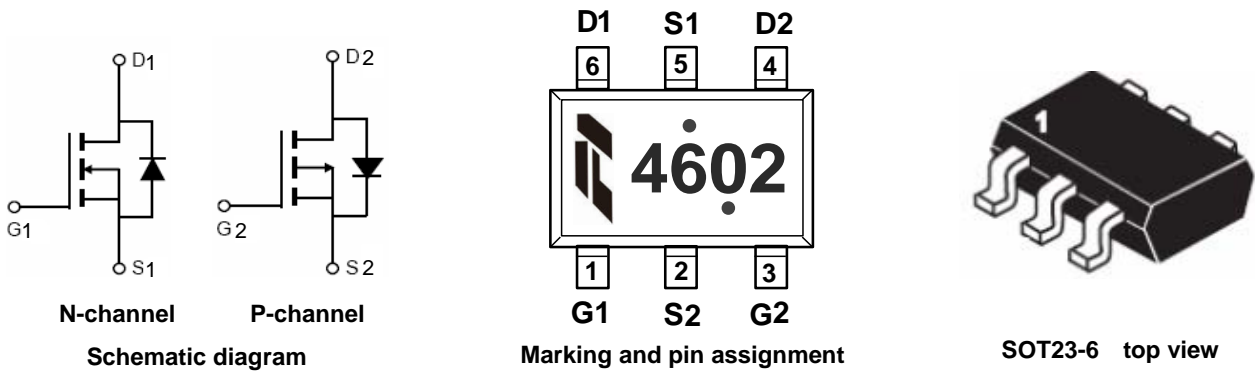

### Absolute Maximum Ratings ( $T_A=25^\circ C$ unless otherwise noted)

Parameter	Symbol	N-Channel	P-Channel	Unit
Drain-Source Voltage	$V_{DS}$	20	-20	V
Gate-Source Voltage	$V_{GS}$	$\pm 12$	$\pm 12$	V
Continuous Drain Current	$I_D$	$T_A=25^\circ C$	4.0	-4.1
		$T_A=80^\circ C$	2.4	-2.5
Pulsed Drain Current <sup>(Note 1)</sup>	$I_{DM}$	16	-16.4	A
Maximum Power Dissipation	$P_D$	1.6		W
Operating Junction and Storage Temperature Range	$T_J, T_{STG}$	-55 To 150		$^\circ C$

### Thermal Characteristic

Thermal Resistance, Junction-to-Ambient <sup>(Note2)</sup>	$R_{\theta JA}$	96	$^\circ C/W$
--	-----------------	----	--------------

N-CH Electrical Characteristics ( $T_A=25^\circ\text{C}$  unless otherwise noted)

Parameter	Symbol	Condition	Min	Typ	Max	Unit
<b>Off Characteristics</b>						
Drain-Source Breakdown Voltage	$BV_{DSS}$	$V_{GS}=0V, I_D=250\mu A$	20	-	-	V
Zero Gate Voltage Drain Current	$I_{DSS}$	$V_{DS}=20V, V_{GS}=0V$	-	-	1	$\mu A$
Gate-Body Leakage Current	$I_{GSS}$	$V_{GS}=\pm 12V, V_{DS}=0V$	-	-	$\pm 100$	nA
<b>On Characteristics (Note 3)</b>						
Gate Threshold Voltage	$V_{GS(th)}$	$V_{DS}=V_{GS}, I_D=250\mu A$	0.45	0.7	1.2	V
Drain-Source On-State Resistance	$R_{DS(on)}$	$V_{GS}=4.5V, I_D=4A$	-	29	38	m $\Omega$
		$V_{GS}=2.5V, I_D=2A$	-	39	48	m $\Omega$
Forward Transconductance	$g_{FS}$	$V_{DS}=5V, I_D=4A$	-	15	-	S
<b>Dynamic Characteristics (Note 4)</b>						
Input Capacitance	$C_{iss}$	$V_{DS}=10V, V_{GS}=0V,$ $F=1.0MHz$	-	582	-	pF
Output Capacitance	$C_{oss}$		-	95	-	pF
Reverse Transfer Capacitance	$C_{rss}$		-	35	-	pF
<b>Switching Characteristics (Note 4)</b>						
Turn-on Delay Time	$t_{d(on)}$	$V_{DD}=10V, R_L=2.5\Omega$ $V_{GS}=4.5V, R_{GEN}=3\Omega$	-	13	-	nS
Turn-on Rise Time	$t_r$		-	4	-	nS
Turn-Off Delay Time	$t_{d(off)}$		-	21	-	nS
Turn-Off Fall Time	$t_f$		-	8	-	nS
Total Gate Charge	$Q_g$	$V_{DS}=10V, I_D=4A, V_{GS}=4.5V$	-	8	-	nC
Gate-Source Charge	$Q_{gs}$		-	2.1	-	nC
Gate-Drain Charge	$Q_{gd}$		-	3.8	-	nC
<b>Drain-Source Diode Characteristics</b>						
Diode Forward Voltage (Note 3)	$V_{SD}$	$V_{GS}=0V, I_S=1A$	-	0.8	1.2	V

P-CH Electrical Characteristics ( $T_A=25^\circ\text{C}$  unless otherwise noted)

Parameter	Symbol	Condition	Min	Typ	Max	Unit
<b>Off Characteristics</b>						
Drain-Source Breakdown Voltage	$BV_{DSS}$	$V_{GS}=0V, I_D=-250\mu A$	-20	-	-	V
Zero Gate Voltage Drain Current	$I_{DSS}$	$V_{DS}=-20V, V_{GS}=0V$	-	-	-1	$\mu A$
Gate-Body Leakage Current	$I_{GSS}$	$V_{GS}=\pm 12V, V_{DS}=0V$	-	-	$\pm 100$	nA
<b>On Characteristics (Note 3)</b>						
Gate Threshold Voltage	$V_{GS(th)}$	$V_{DS}=V_{GS}, I_D=-250\mu A$	-0.45	-0.7	-1.2	V
Drain-Source On-State Resistance	$R_{DS(on)}$	$V_{GS}=-4.5V, I_D=-4A$	-	32	41	m $\Omega$
		$V_{GS}=-2.5V, I_D=-2A$	-	39	48	m $\Omega$
Forward Transconductance	$g_{FS}$	$V_{DS}=-5V, I_D=-4A$	-	15	-	S
<b>Dynamic Characteristics (Note4)</b>						
Input Capacitance	$C_{iss}$	$V_{DS}=-10V, V_{GS}=0V,$ $F=1.0MHz$	-	952	-	PF
Output Capacitance	$C_{oss}$		-	131	-	PF
Reverse Transfer Capacitance	$C_{rss}$		-	117	-	PF
<b>Switching Characteristics (Note 4)</b>						
Turn-on Delay Time	$t_{d(on)}$	$V_{DD}=-10V, R_L=3.6\Omega$ $V_{GS}=-4.5V, R_{GEN}=3\Omega$	-	12	-	nS
Turn-on Rise Time	$t_r$		-	5	-	nS
Turn-Off Delay Time	$t_{d(off)}$		-	30	-	nS
Turn-Off Fall Time	$t_f$		-	10	-	nS
Total Gate Charge	$Q_g$	$V_{DS}=-10V, I_D=-4A, V_{GS}=-4.5V$	-	7.8	-	nC
Gate-Source Charge	$Q_{gs}$		-	1.2	-	nC
Gate-Drain Charge	$Q_{gd}$		-	1.6	-	nC
<b>Drain-Source Diode Characteristics</b>						
Diode Forward Voltage (Note 3)	$V_{SD}$	$V_{GS}=0V, I_S=-1A$	-	-0.8	-1.2	V

**Notes:**

1. Repetitive Rating: Pulse width limited by maximum junction temperature.
2. Surface Mounted on FR4 Board,  $t \leq 10$  sec.
3. Pulse Test: Pulse Width  $\leq 300\mu s$ , Duty Cycle  $\leq 2\%$ .
4. Guaranteed by design, not subject to production

N- Channel Typical Electrical and Thermal Characteristics (Curves)

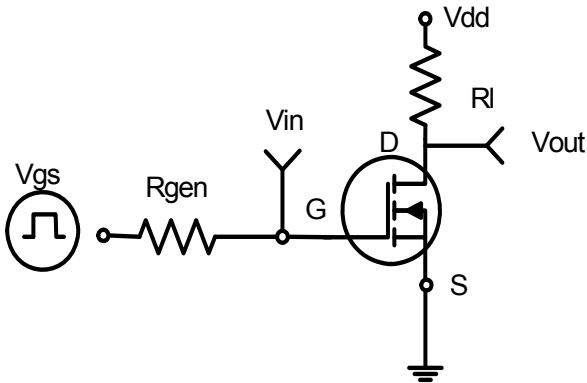

Figure 1: Switching Test Circuit

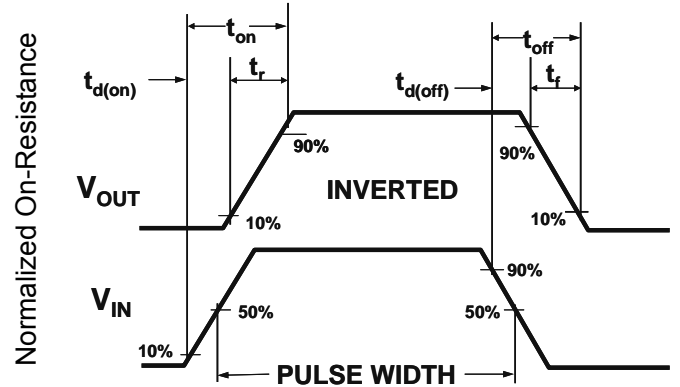

Figure 2: Switching Waveforms

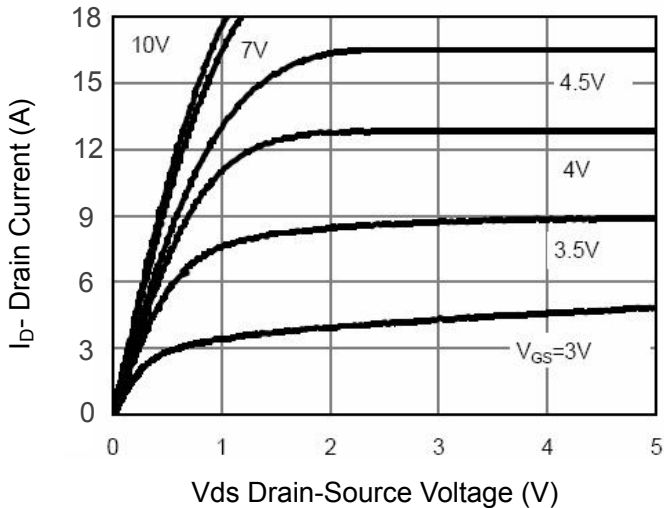

Figure 3 Output Characteristics

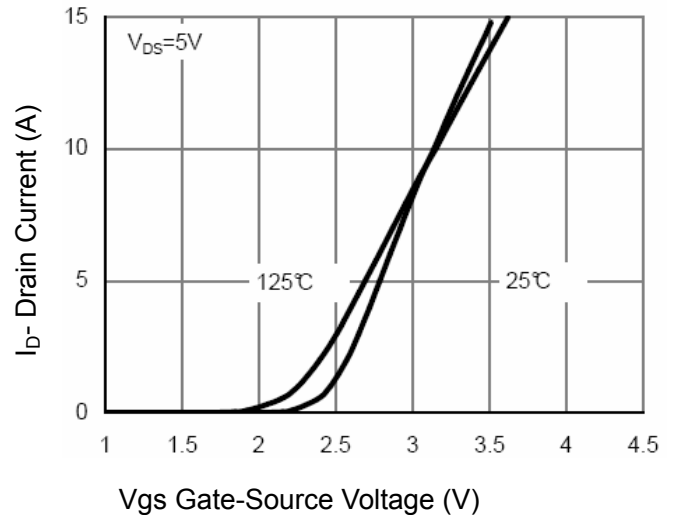

Figure 4 Transfer Characteristics

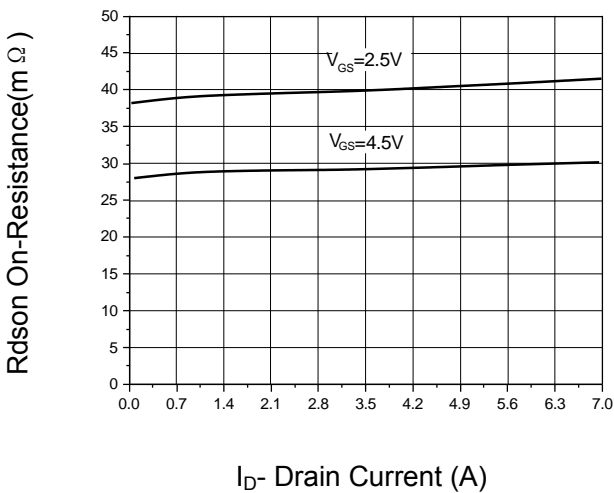

Figure 5 Drain-Source On-Resistance

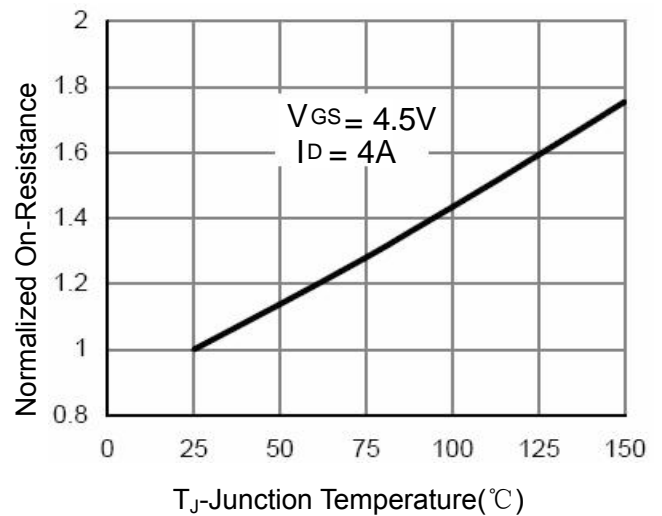
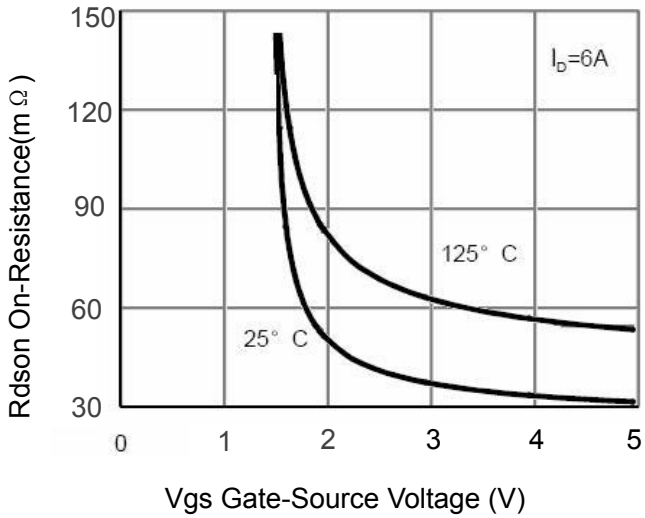
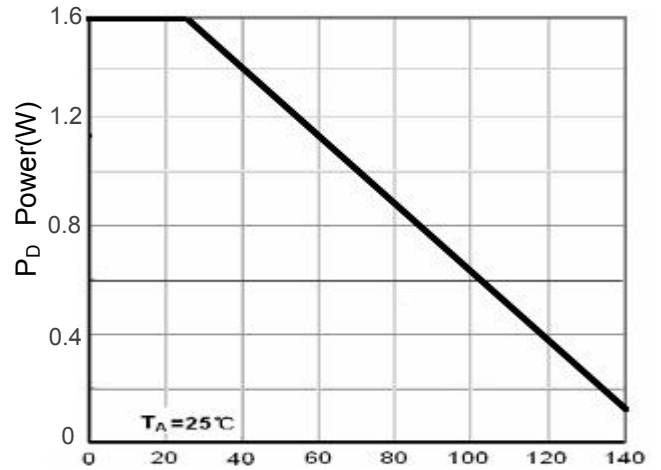

Figure 6 Drain-Source On-Resistance



Vgs Gate-Source Voltage (V)  
**Figure 7 Rdson vs Vgs**



Tj Junction Temperature (°C)  
**Figure 8 Power Dissipation**

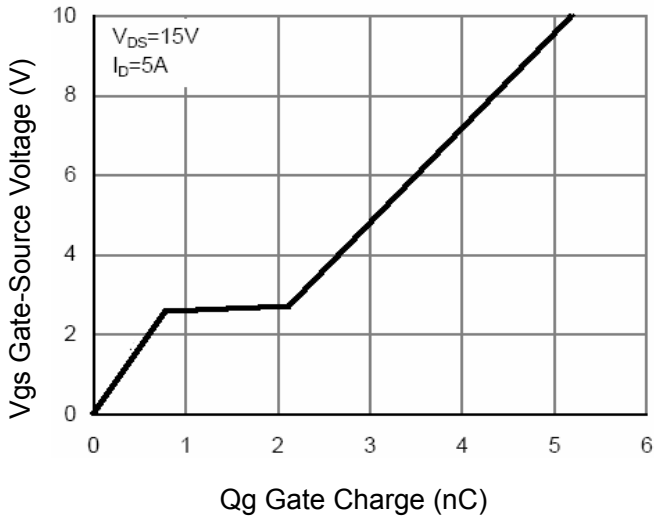

Qg Gate Charge (nC)  
**Figure 9 Gate Charge**

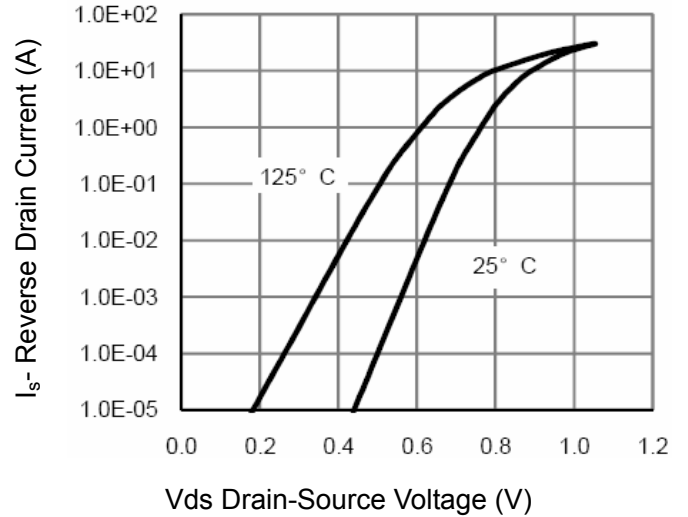

Vds Drain-Source Voltage (V)  
**Figure 10 Source- Drain Diode Forward**

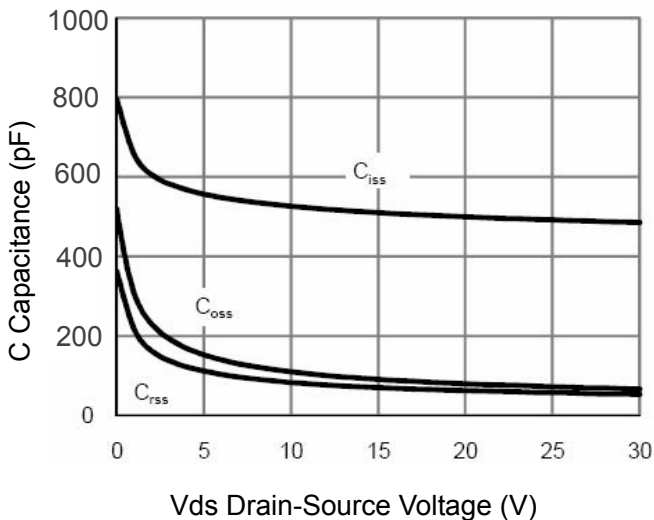

Vds Drain-Source Voltage (V)  
**Figure 11 Capacitance vs Vds**

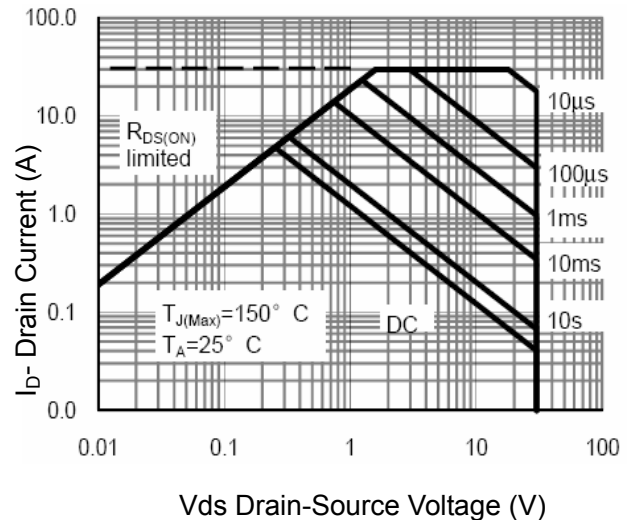

Vds Drain-Source Voltage (V)  
**Figure 12 Safe Operation Area**

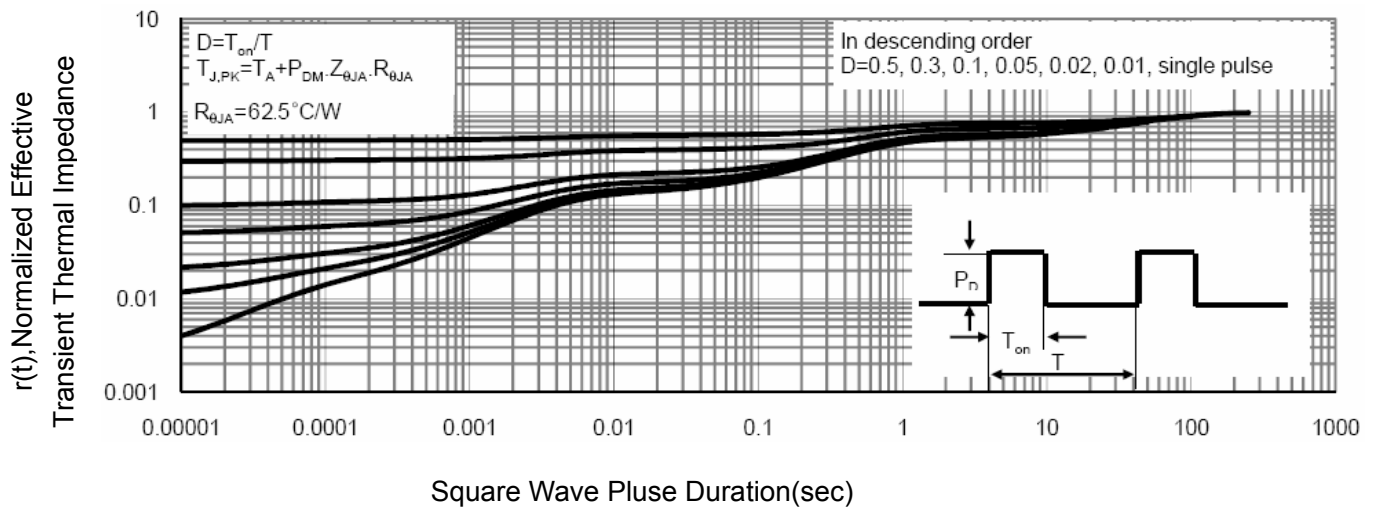

Figure 13 Normalized Maximum Transient Thermal Impedance

P- Channel Typical Electrical and Thermal Characteristics (Curves)

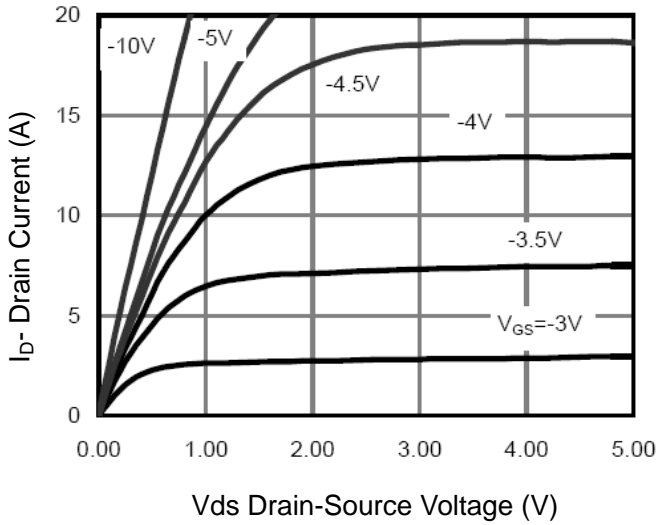

Figure 1 Output CHARACTERISTICS

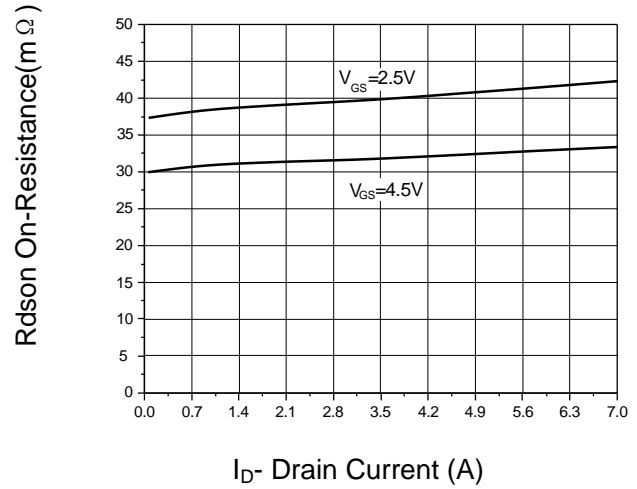

Figure 2 Drain-Source On-Resistance

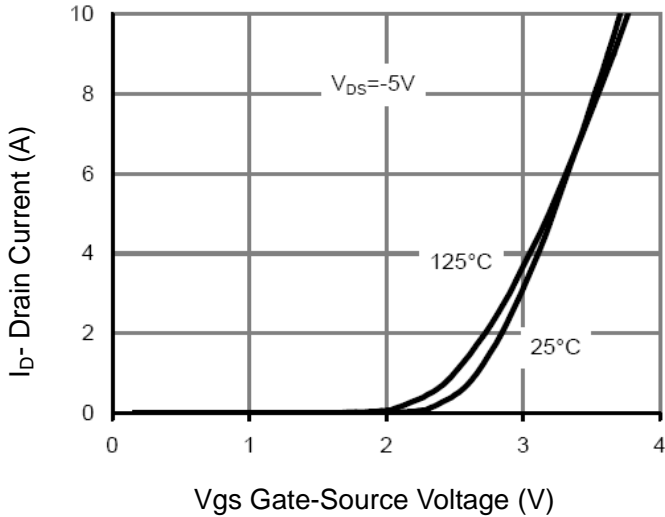

Figure 3 Transfer Characteristics

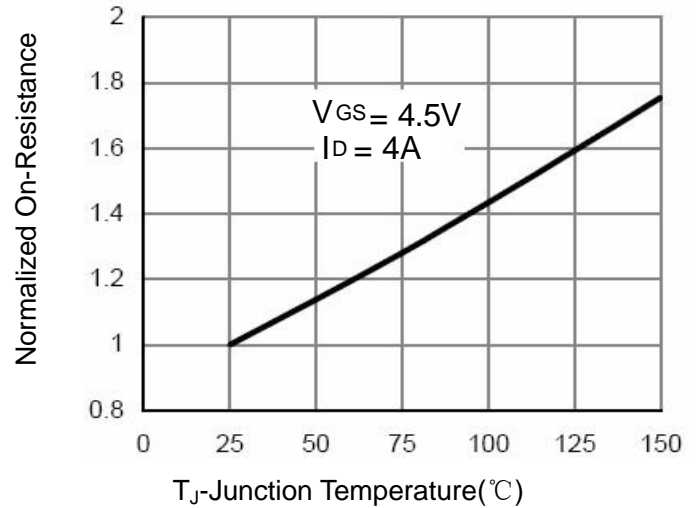

Figure 4 Drain-Source On-Resistance

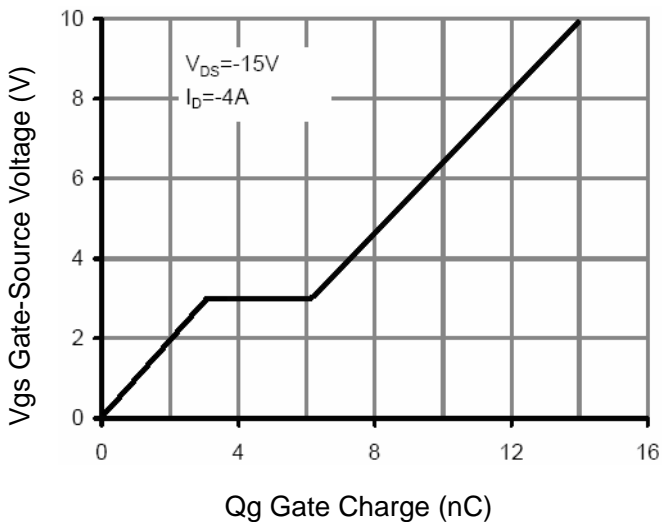

Figure 5 Gate Charge

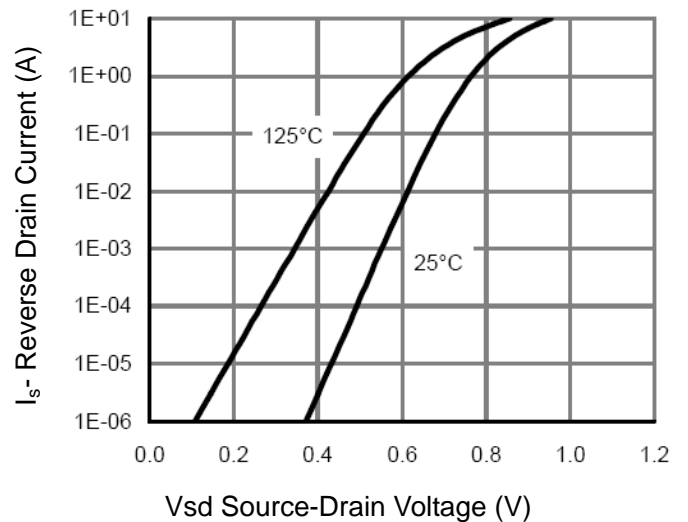

Figure 6 Source- Drain Diode Forward

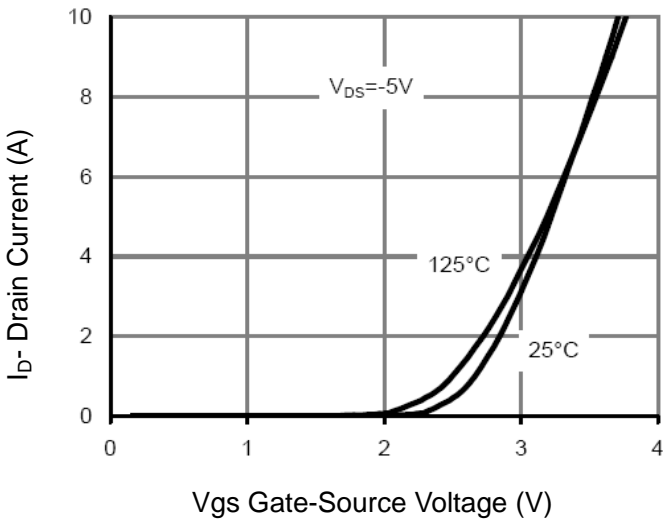

Figure 7 Transfer Characteristics

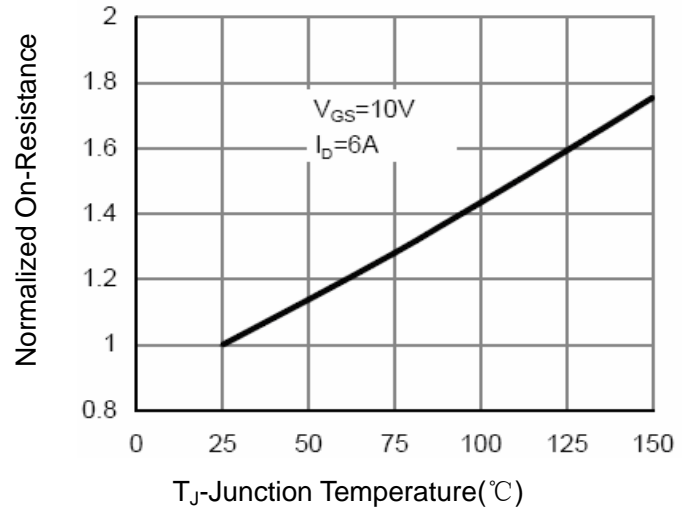

Figure 8 Drain-Source On-Resistance

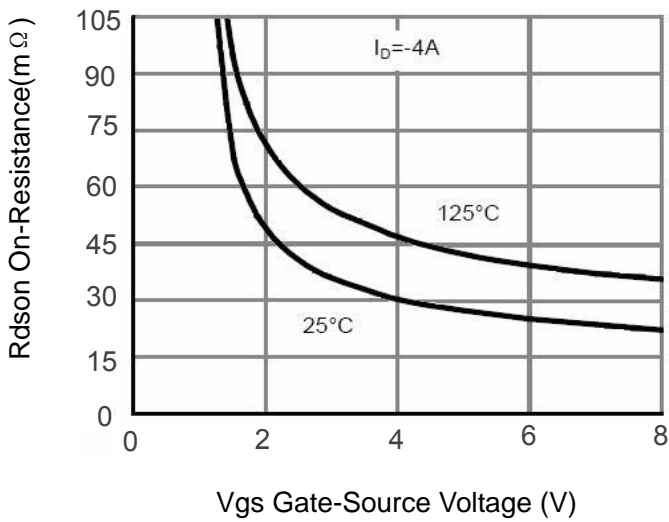

Figure 9 Rdson vs Vgs

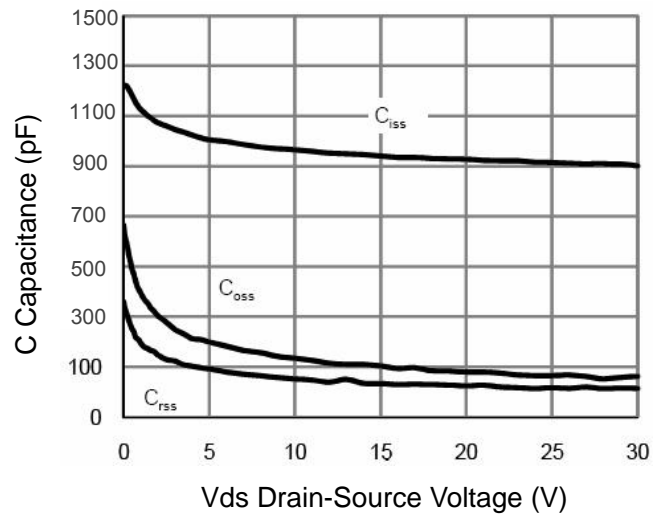

Figure 10 Capacitance vs Vds

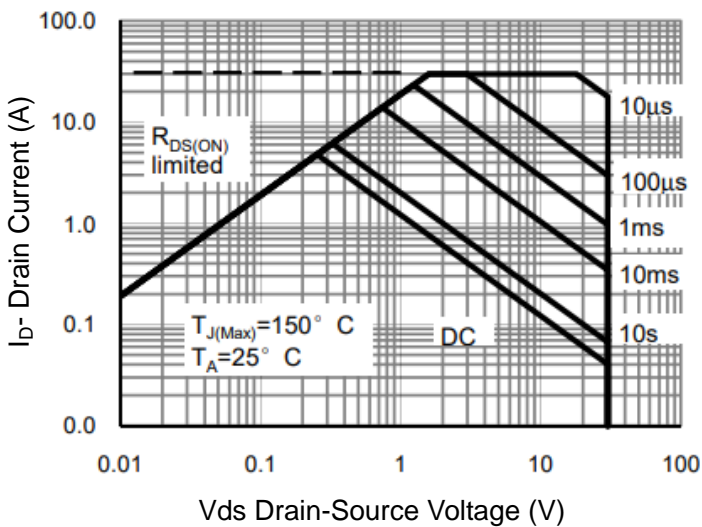

Figure 11 Safe Operation Area

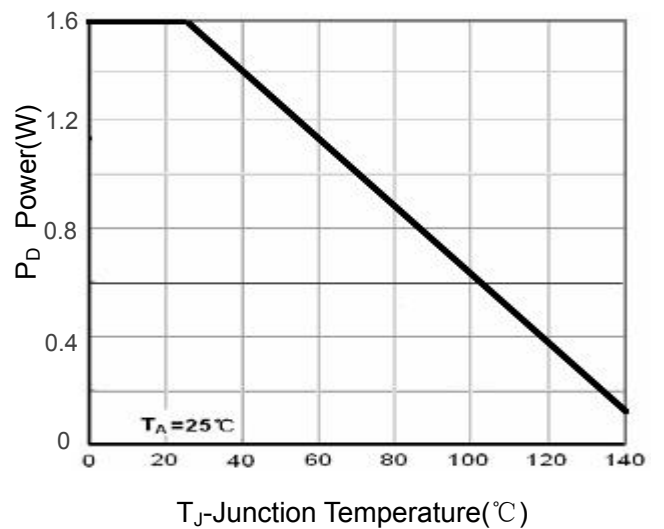
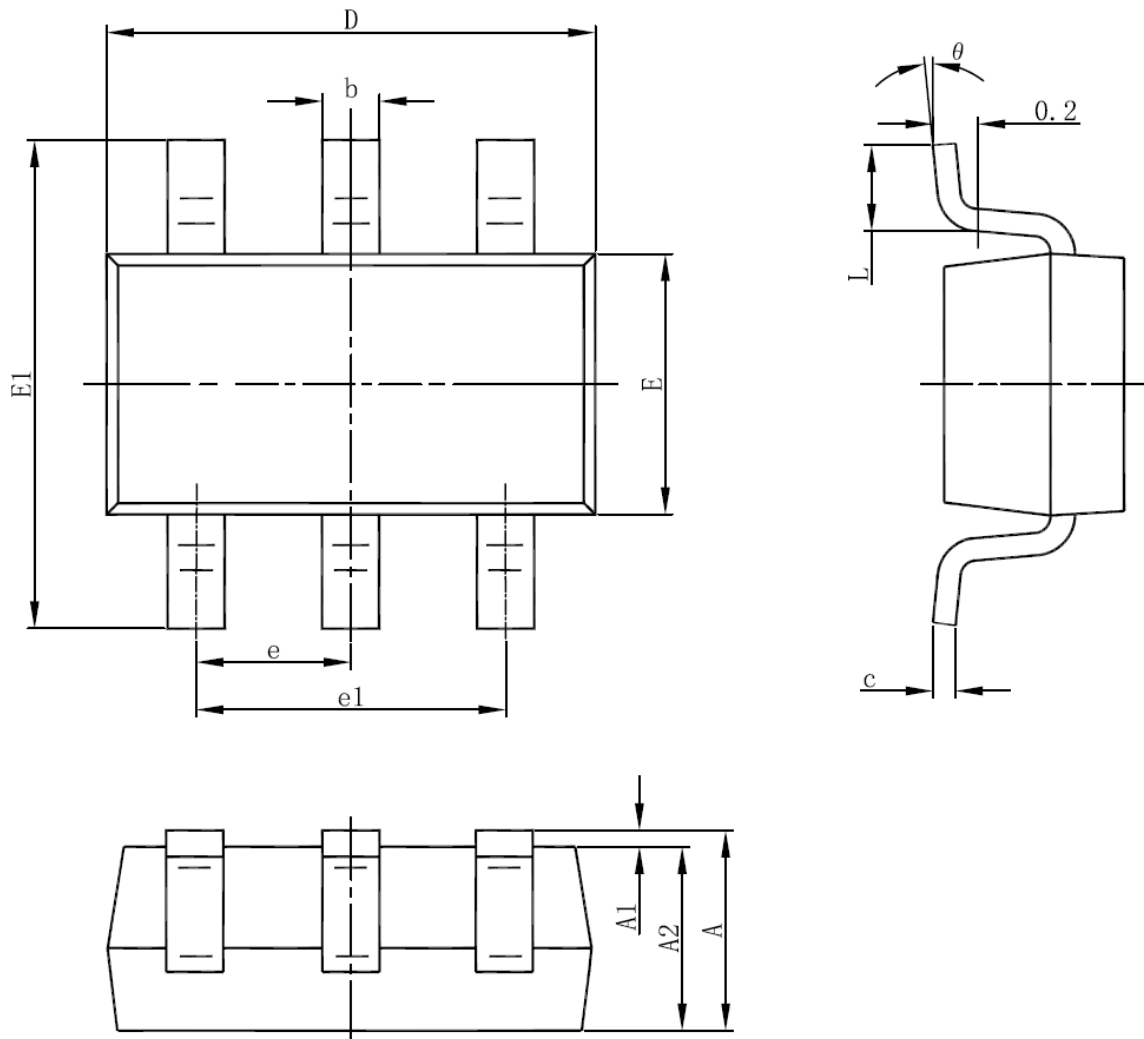

Figure 12 Power Dissipation



## Package Information : SOT23-6



Symbol	Dimensions In Millimeters		Dimensions In Inches	
	Min	Max	Min	Max
A	1.050	1.250	0.041	0.049
A1	0.000	0.100	0.000	0.004
A2	1.050	1.150	0.041	0.045
b	0.300	0.500	0.012	0.020
c	0.100	0.200	0.004	0.008
D	2.820	3.020	0.111	0.119
E	1.500	1.700	0.059	0.067
E1	2.650	2.950	0.104	0.116
e	0.950(BSC)		0.037(BSC)	
e1	1.800	2.000	0.071	0.079
L	0.300	0.600	0.012	0.024
$\theta$	0°	8°	0°	8°